

SECTION B-B
TYPICAL SECTIONS
HORIZ. 1"=10'
VERT. 1"=2'

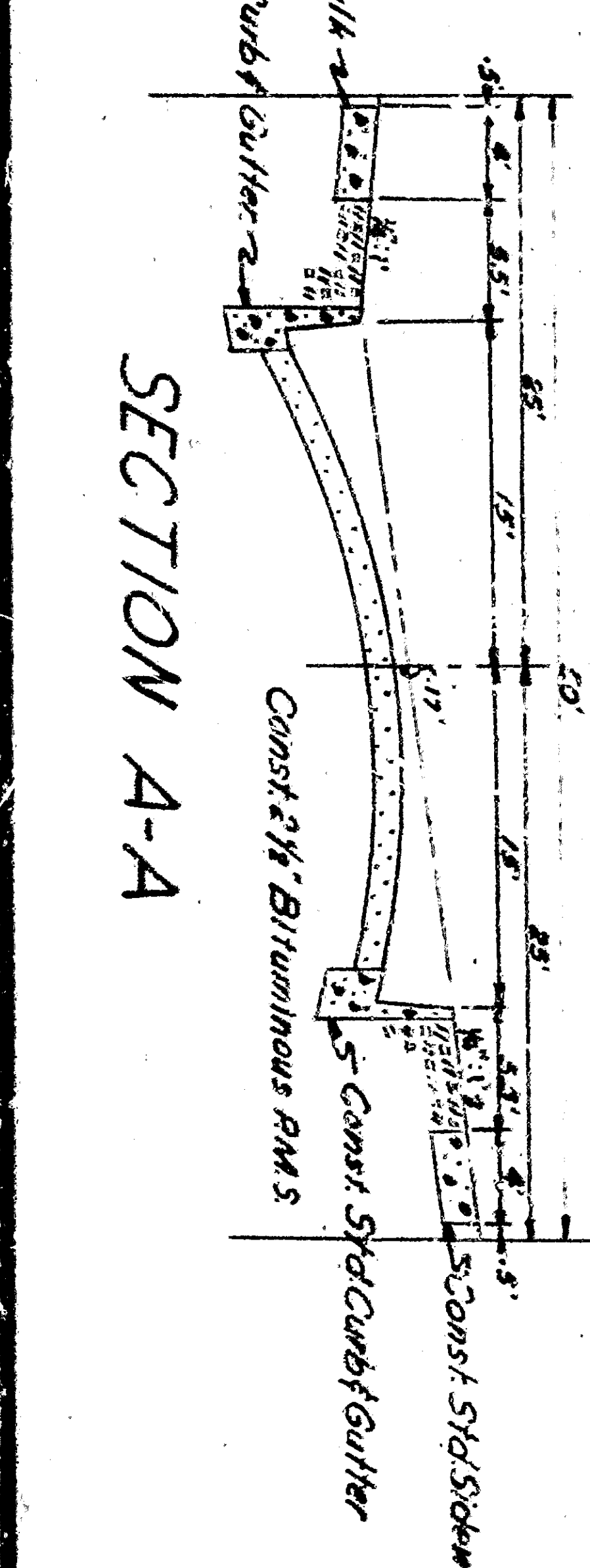

SECTION A-A
TYPICAL SECTIONS
HORIZ. 1"=10'
VERT. 1"=2'

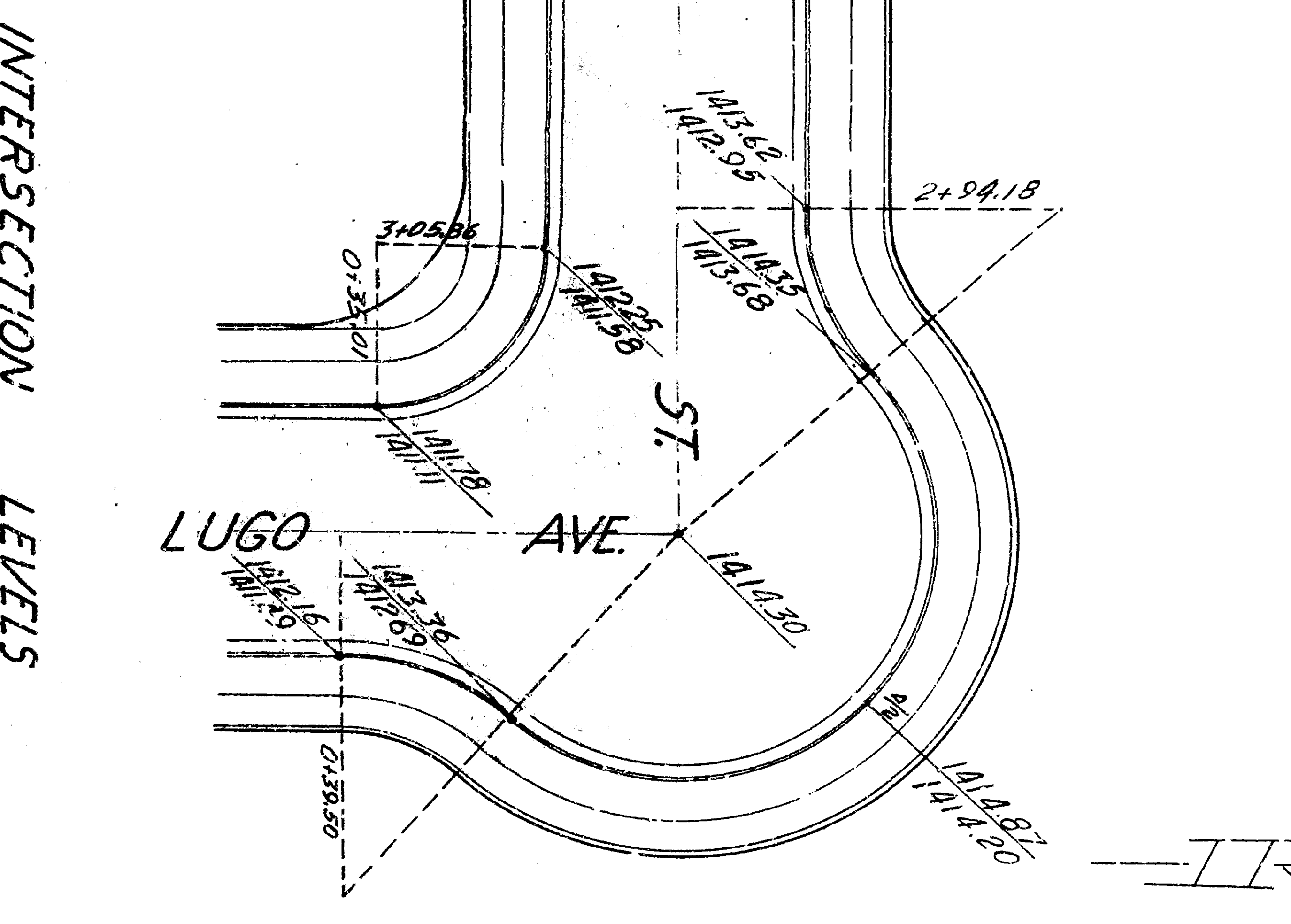

INTERSECTION LEVELS
SCALE: 1"=20'

IMPROVEMENT PLANS
TRACT 3791
DATE: June 30, 55
C.C. 2354

PLAN
SCALE: 1"=40'

NOTES:
All work embodied on these plans shall be done in accordance with applicable provisions of Specifications No. 227.
Multiple frames and sheets to be considered for offset sheet grids by joining contractor after posting.
Exact location of sewer lateral to be determined in the field.

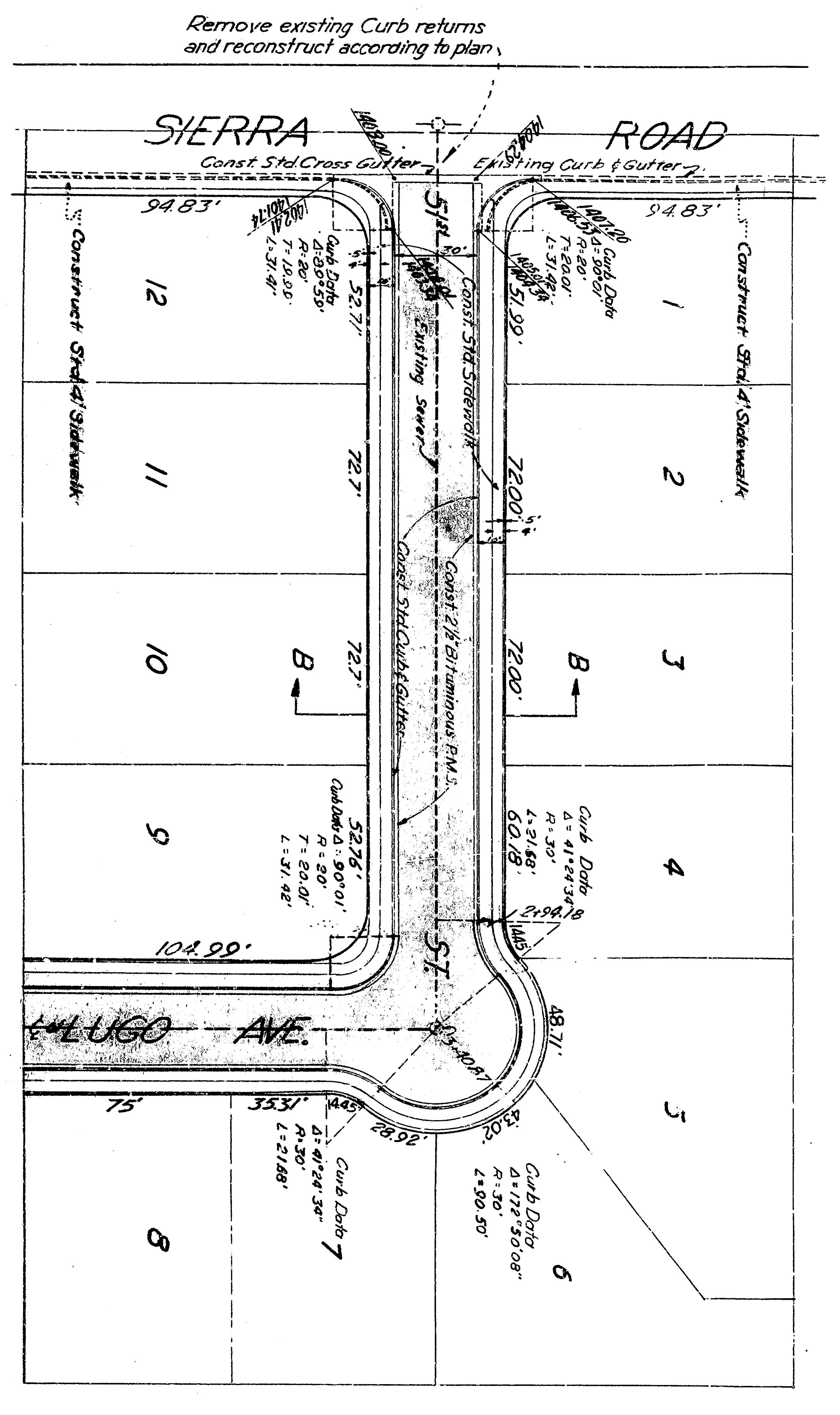


PLAN SCALE: 1"=40'

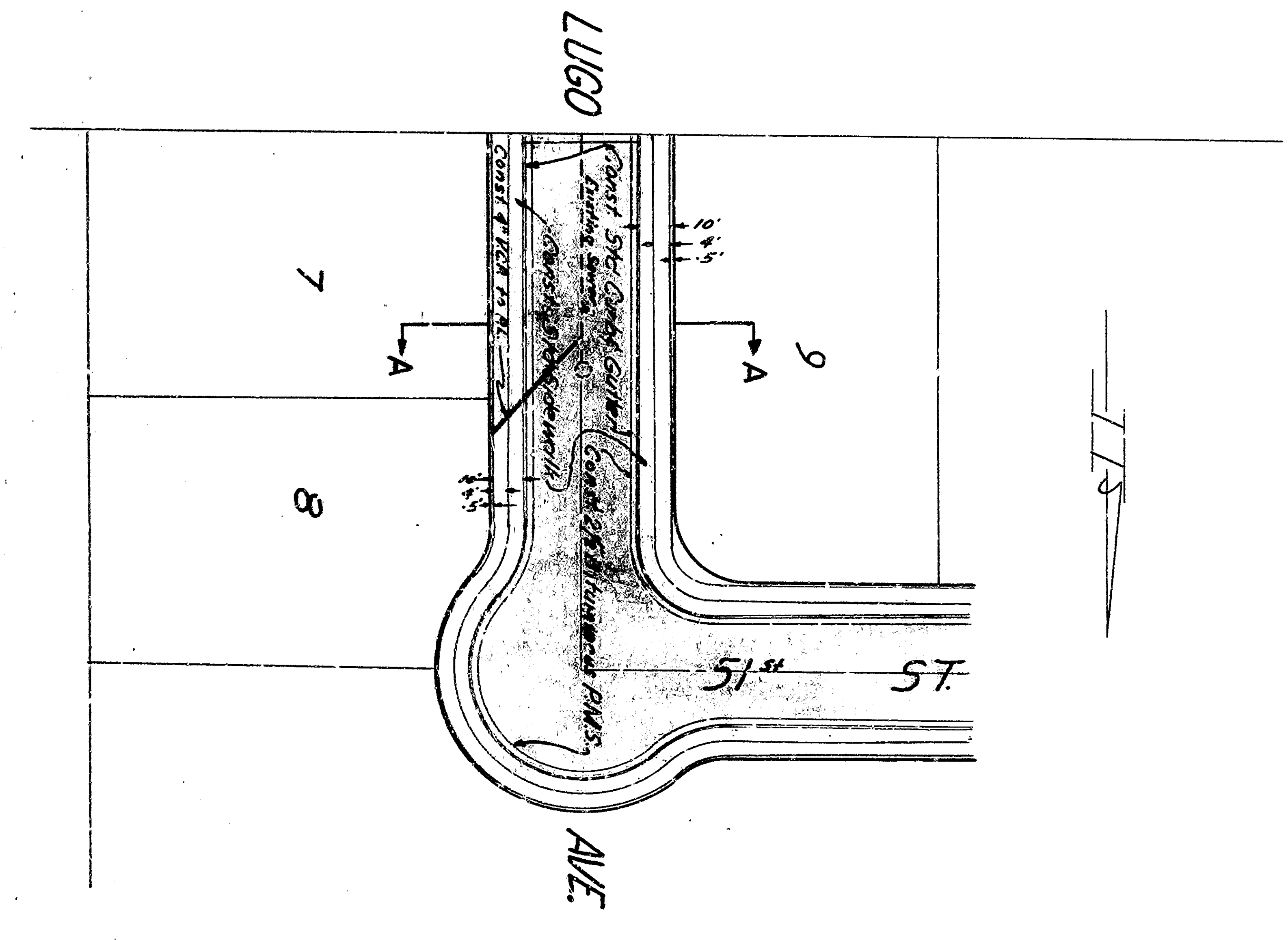

INTERSECTION LEVELS SCALE: 1"=20'

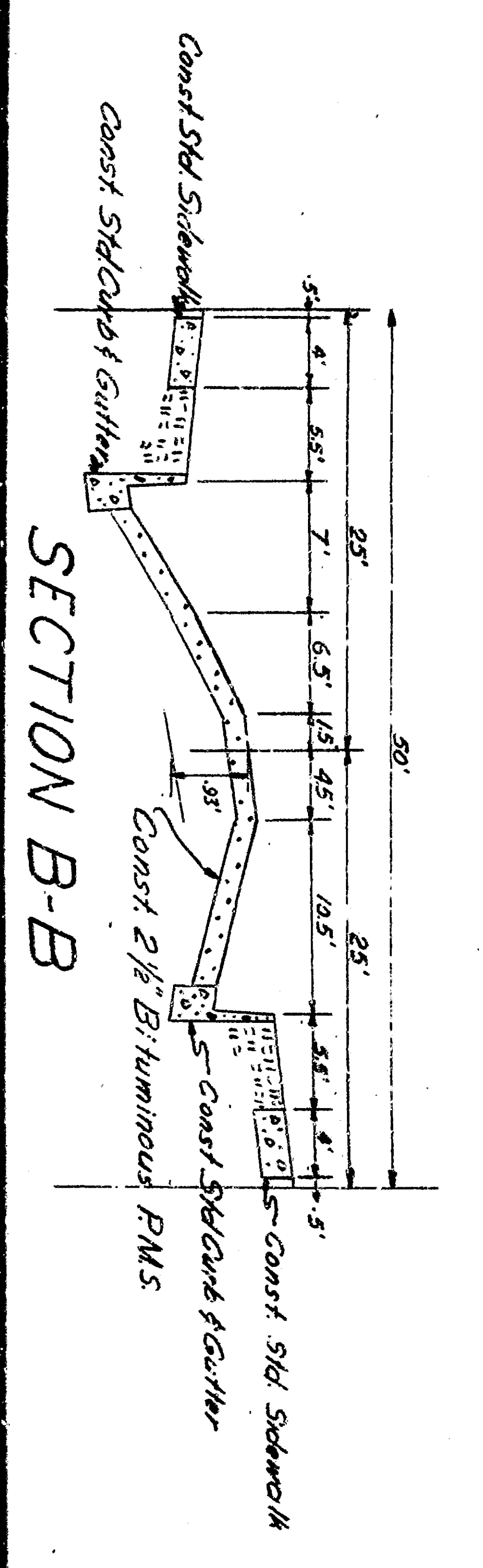
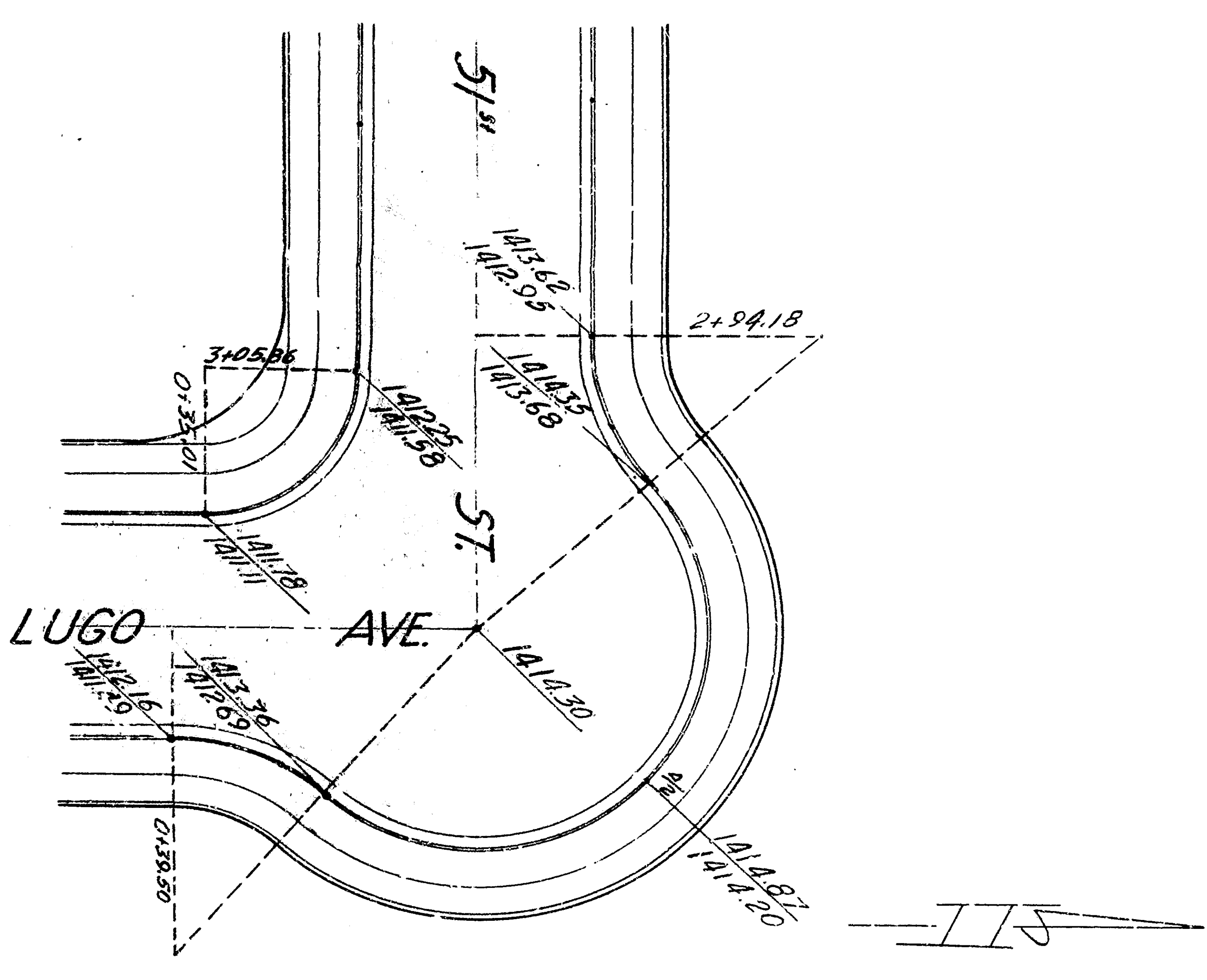

SECTION B-B TYPICAL SECTIONS SCALE: 1/2\"/>

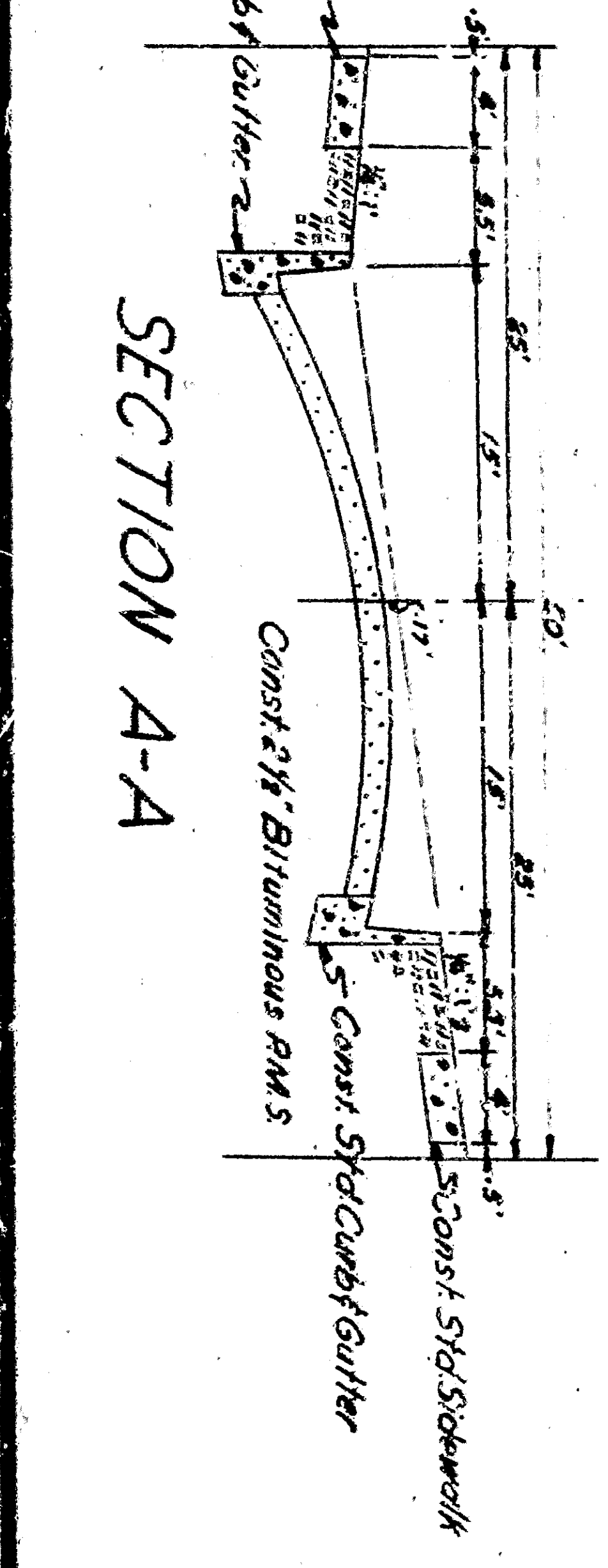

SECTION A-A TYPICAL SECTIONS SCALE: 1/2\"/>

IMPROVEMENT PLANS TRACT 3791

DATE: June 30, 55

2354